

SANGEAN

ATS-505

Operating instructions

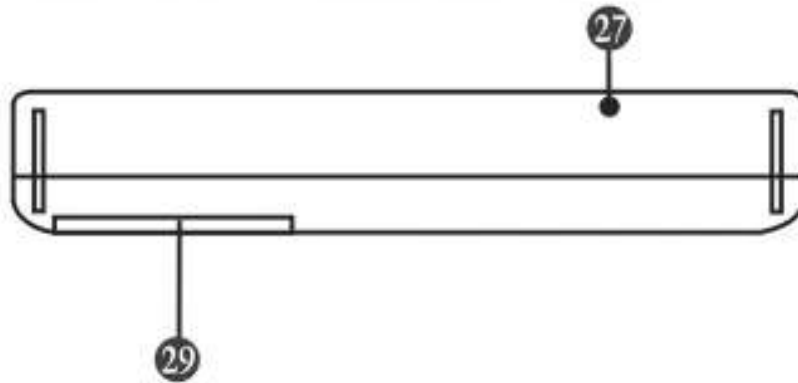

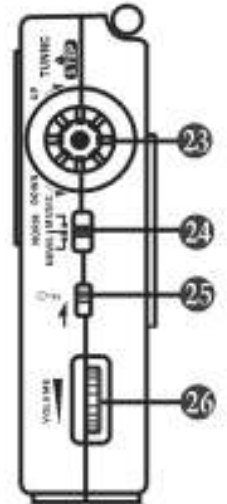
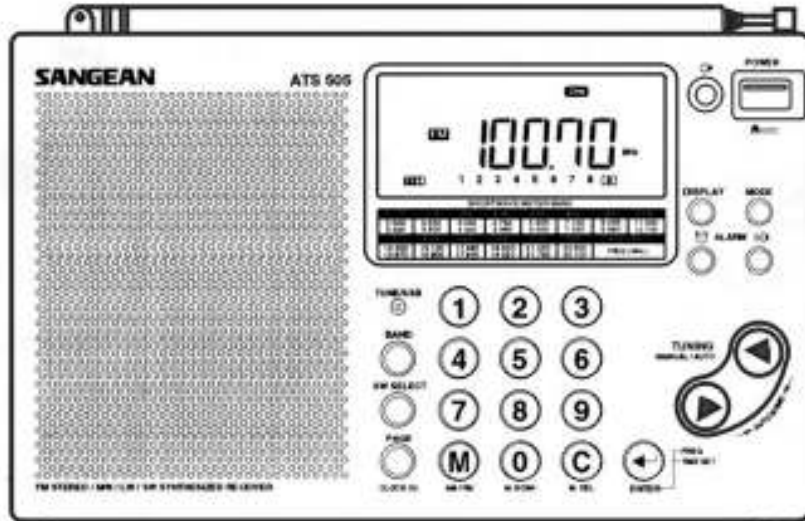
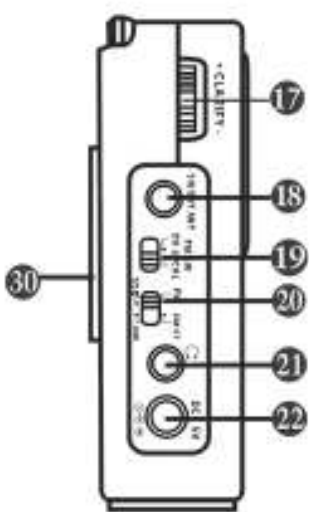
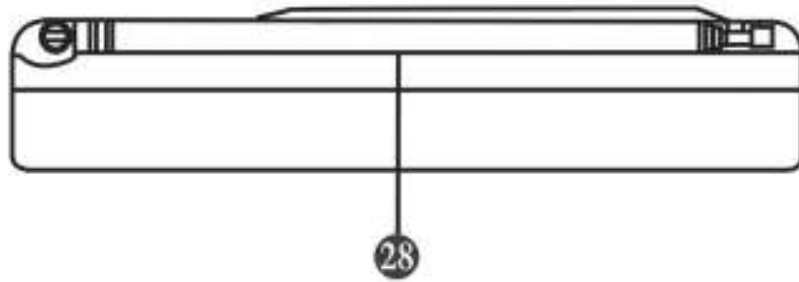

Control Locations

- ① Power/Sleep
Power On/off/Alarm off/sleep function
- ② Display
Switch between radio frequency and time while radio is power on
- ③ Mode
Mode set up (please see below mode button set up)
- ④ Radio alarm
- ⑤ Buzzer alarm
- ⑥ Tuning Up/Down
- ⑦ Enter command button for frequency and time set
- ⑧ Selection cancel
- ⑨ Numbered buttons and memory scan (the 0 Button)
- ⑩ Memory set buttons and AM/PM selection for 24-hour format
- ⑪ Real/dual time button and SW memory page
- ⑫ SW meter band selection
- ⑬ Band selection
- ⑭ Tuning LED indicator (Green)/SSB on (Red)
- ⑮ Display (L.C.D.)
- ⑯ Display illuminated button (Light)
- ⑰ Clarify
SSB fine tune
- ⑱ External Short Wave antenna jack
- ⑲ DX/Local \switch
- ⑳ FM Mono/Stereo.SSB/AM switch
- ㉑ Earphones socket
- ㉒ DC input socket
- ㉓ Rotary tuning knob /Fine tuning
- ㉔ Music/Normal /News Tone control
- ㉕ LICK switch
- ㉖ Volume control
- ㉗ Reset
- ㉘ Telescopic Antenna
- ㉙ Battery compartment
- ㉚ Folding stand

Display information

- Ⓐ Short Wave Broadcast band
- Ⓑ FM stereo indication
- Ⓒ Sleep (auto shut off)status
- Ⓓ Lock on
- Ⓔ Buzzer alarm set
- Ⓕ Radio alarm set
- Ⓖ Tuning step
- Ⓗ Short wave meter band
- Ⓘ kHz for MW, LW, SW and MHz for FM band
- Ⓜ Low battery indicator
- Ⓚ Memory bar
- Ⓛ Frequency and Time display
- Ⓜ Memory Page 1/2
- Ⓝ Radio band and AM/PM (for 12 hours format)indicator
- Ⓞ Real/Dual time

•Choosing a power supply

This radio can be operated using.

4 Alkaline UM-3(LR6)(AA size)batteries.

Household AC adapter(not supplied).

Installing batteries

- 1.Position the radio face down
- 2.Press the catch marked "▼" and slide in the direction shown.
- 3.Insert the 4 UM-2 (LR6)(AA size) batteries.
4. Replace the battery cover.

Battery replacement

The battery indicator will display the battery condition for approx.7 seconds after the radio is switched off. If the battery strength indicator is shown below 2.the batteries should be replaced. After removing the batteries you have approx.3 minutes to replace the batteries after which clock and memory information will be lost.

Low battery warnings

- 1.Replace batteries if display flashes "🔋".
- 2.Replace batteries if press power button, the radio still not operate.

Using the AC adapter

Insert the adapter plug into the socket 6VDC on the left side of the radio. Plug the adapter into a standard mains socket outlet. Whenever the adapter is used, the batteries are automatically disconnected.

The mains adapter should be disconnected from the mains supply when not in use for long time.

We would recommend that the receiver operates via the AC adapter whenever possible, add with battery operation for occasional or stand-by use only.



The clock will start running when the batteries are installed or the adapter is plugged in. The display will show "0:00" or "AM 12:00" and real time icon.

The real time can be set.



1. When the radio is switched off
2. If the radio switched on, press DISPLAY button to time status.
3. Press "ENTER" button for more than 2 seconds until "  " real time symbol and
4. Set the correct time by pressing the numbered buttons. As you press each button, the corresponding number will show on the display.
5. If you press wrong button, after pressing the ENTER button. The radio will beep and "Err" flashed in the display.
6. Press Enter button again to complete the clock setting.

Note:



You may change 24 hour to 12 hour format or vice versa by pressing MODE and related buttons described later.

Setting the dual time

In addition to real time, a dual time can be programmed into the radio.

1. Press Real/Dual time button, the Dual time symbol "  " will flash.
2. Press ENTER button, display dual time symbol "  " will stop flashing.
3. Press ENTER button again for more than 2 seconds until dual time symbol "  " flashes, set the dual time by pressing the numbered buttons.
4. The rest of the operation is same as setting the real time.

Note:

- a. To temporarily change between real and dual time mode, press Real/dual time button. The dual time icon and dual time will be shown in the display.. After approx. 7 seconds, the display will return to show real time.
- b. To permanently change the display to dual time, press Real/Dual time button followed by the ENTER button. "  " Dual time icon will appear on the display.
- c. To permanently change the display back to real time mode, press Real/Dual time button followed by the ENTER button. The "  " will be removed from display.

•Waveband selection

There are four waveband selection by pressing BAND button

Waveband	Frequency coverage	Aerial Type
FM	87.50- 108 MHz	Telescopic Full extend the aerial, angle and rotate for best reception.
MW	520- 1710 kHz	Internal
SW	1711- 29999 kHz	Telescopic Fully extend the aerial for best reception.
LW	153- 279kHz	Internal

Stations may be selected by using any of the five different available tuning methods: Direct Tuning, Manual tuning, Scan tuning, Memory Recall Tuning and APS on MW, FM and LW bands.

Direct tuning

Example : To tune to 100.70 MHz on the FM band.

1. Press the POWER on/off button to turn on the radio.
2. Select the required FM band by pressing BAND button.
3. Press ENTER - Freq./time Set button, display shows "---".
4. Press the numbered buttons marked 1,0,07., then press ENTER button again, the frequency will now appear in the display.

Note:

There is no decimal point, therefore you press the number button, make sure you have selected the required waveband, otherwise the operation may switch to other waveband.

5. Extend the aerial fully and rotate for best FM reception.
6. Adjust the volume control for comfortable listening.
7. When selecting a stereo FM station and using stereo earphones, make sure the FM mode switch is in the stereo position.

Manual tuning by tuning UP/DOWN button

1. Press the POWER on/off button to turn on the radio.
2. Select a waveband by pressing BAND button.
3. A single press on either Tuning UP or Down button will change the frequency up or down.

Note:

Each press of Up or Down button will change the frequency in increment of FM: 100kHz or 200kHz depending on the versions.

MW: 9kHz or 10kHz depending on the versions.

SW: 5kHz

LW: 9kHz

Manual tuning by Rotary tuning knob

Rotary tuning is accomplished using the convenient Rotary Tuning Knob. Original tuning step is as below but can be changed by the MODE button as described later.

BAND	FM	MW	LW	SW
Step	100 or 200 kHz	9kHz or 10 kHz	9 kHz	5 kHz
Fine Tune	50 kHz	1 kHz	1 kHz	1 kHz

Note:

Fine tune can be operated by pressing the rotary tuning knob in. Display will show fine tune step then the last frequency tuned.

Note:

During fine tune operation, any press to other functional buttons will cause Fine Tune back to normal tune.

Scan tuning

1. Turn on the radio by pressing the POWER on/off button.
2. Select a waveband.
3. Press and hold down either the tuning UP or DOWN button for more than half a second to commence scan tuning. The radio will scan all frequencies in the selected band and stop automatically each time it finds an active station.
4. Press and hold down either the tuning UP or DOWN buttons for more than half a second to resume scan tuning. When the waveband end is reached, the radio will beep and continue tuning from the opposite waveband end.
5. Adjust the volume control for comfortable listening.

Memory tuning

You may store up to 45 preset stations in memory. 18 on SW in 2 pages, 9 each on FM, MW and LW bands. To store a station in preset memory, proceed as follows.

1. Turn on the radio by pressing the POWER on/off button.
2. Tune to the desired frequency using one of the previous described tuning methods.

3. Press the button marked M (memory), display M and suggested preset number will flash, press ENTER to store your station in that memory position.
4. Preset positions may be exchanged easily. Select preset station that is to be changed, press memory button (M and existing memory position will flash). select new preset position. Preset will be exchanged automatically.
5. SW band has 18 presets (in two pages). When presets 1-9 are full, press PAGE button to select Page 2. Display will show M2. and an additional 1-9 presets can be set for a total of 18 presets.

Note:

1. If all presets have been used, pushing M button will display FULL on LCD. If you still desire to store new station, push any button of 1-9 where new station is to be stored and hold for more than 2 seconds. New station will be put into memory in position selected and original station in this position will be replaced.
2. All preset stations are indicated by on the display. If a station has already been put into the memory. it will show preset position on display.

•Recalling a station

1. Turn on the radio by pressing the POWER on/off button.
2. Select the waveband for the station required.
3. Press the numbered button corresponding to the preset memory location for the required station. The radio will instantly tune to the station and display will show its frequency and memory location.

Select Short Wave Meter Band

1. Turn on the radio by pressing the POWER on/of button.
2. Press BAND button to select the SW waveband.
3. Press SW SELECT button to select the required SW meter band, display will appear low end frequency and SW meter band it belongs to. This radio covers SW 120 to 11 meter band.

APS (auto Preset System)

This radio provides an easy to use feature called APS (Auto Preset System) which operated on FM, MW and LW bands.

1. Turn on the radio by pressing POWER on/off button.
2. Press BAND button to select the required waveband.

3. Press Tuning UP and DOWN button at the same time for more than 2 seconds. The radio will beep and then scan from the lowest frequency on the selected band. Automatically storing stations in preset memory based on signal strength.
4. After APS is completed, a beep will be heard. The display will show M1 and the strongest station for your area.
5. If during APS operation, no stations are found, display will show lowest frequency of selected band.

Note:

1. The maximum number of preset is 9 each on FM/MW/LW bands. If during APS operation more than 9 presets are found, there will be only 9 stations stored in the preset memories.
2. The SW band has no APS function.
3. All previous stored preset stations will be erased when APS operation commences.
4. APS operation can be cancelled by pressing the POWER on/off

Memory Scan

This radio provides a feature called Memory Scan, when activated will scan the Preset memories.



1. Turn on the radio by pressing the POWER button. Select the required waveband.
2. Press the M.SCAN button, the radio will scan each preset memory in turn-pause for 7 seconds on each memory before continuing on to the next memory. When the required preset is reached, press any button to stop memory scan.

Setting the alarm (standby)

The alarm can be set with the radio power on or off.

If the radio is switched on, press DISPLAY button display the time.

Setting Radio Alarm



1. Press RADIO ALARM button , display radio alarm icon  will flash and show the last alarm time set. Press the number buttons then ENTER to set RADIO alarm time.
2. To verify the alarm time, Press RADIO ALARM button to display the alarm time followed by ENTER button to return to real time mode.
3. To cancel radio alarm set, press RADIO ALARM button, display will show previous alarm set status then press C (Cancel) to cancel radio alarm set. Display alarm icon will disappear.

Note:

1. When alarm is on, press POWER button to turn off the alarm for 24 hours.
2. Radio alarm on will last for one hour if not turned off by pushing the POWER button.
3. Turn the radio to the required station before setting the radio alarm. When the alarm is on, the radio will play last station selected.

Setting the HWS (Humane Wake System) alarm

A repeating beep tone will sound when using the HWS alarm. The alarm beep will increase in volume every 15 seconds for one minute followed by 1 minute silence before repeating the cycle. The HWS alarm will last for one hour unless turn off by pushing the POWER button.

1. The HWS alarm is set in the same way as the radio alarm except pushing HWS alarm button . And display will appear .
2. The HWS alarm can be turned off by pressing the POWER button.
3. To cancel HWS alarm set, follow the way to cancel Radio alarm.

Setting the sleep timer

The sleep timer will automatically switch off radio after a preset time has elapsed.

1. Press and continue to hold down the POWER/SLEEP button, the display will cycle through available sleep time 60-30-15-120-90-60. Release the SLEEP button when the required sleep time appears in the display. The SLEEP symbol together with frequency will appear in the display. After 2 seconds, display will be back to display frequency.
2. To cancel the sleep function, press the POWER button, the SLEEP symbol will disappear and the display will revert to show real time and radio will be off.

MODE button set up

To meet different requirements from various markets, you may change the initial Setting by pressing MODE and related numbered buttons described as below.

Numbered key 8 key 1 key

1 FM 100kHz FM 200 kHz
 tuning step tuning step

2. MW 9 kHz MW 10 kHz

3 12 hour format 24 hour format

4 Beep tone off Beep tone on

5 Memory
 Rearranged

Complete with ENTER button

For example, if you like to change from MW 10 kHz to 9 kHz, press MODE, numbered button 2 , 0 , then complete with ENTER button.

You can rearrange your memory stations from low frequency to high frequency by Pressing MODE, numbered button 5, 0 or 5, 1 then complete with(ENTER) button.

SSB (single side band)/Clarify(+,-)

Some SW and LW stations transmit in Morse Code using a form of transmission Called continuous wave (CW). Some SW stations use a special type voice transmission called single side band (SSB).

To tune to a CW or SSB station, select the band and frequency and adjust the antenna. In addition, switch the SSB switch to SSB position, Tuning/SSB LED will be on Red. Then beginning at its midpoint, slowly adjust the CLARIFY dial until reception becomes clear. You may at the same time use the rotary FINE tuning for best SSB reception.

When a station is found, the Tuning/SSB LED will become in orange

CLARIFY tuning range can be ± 1.5 kHz

FM Mono/Stereo

To listen to FM stereo broadcasts, tune to the required station, plug in headphones and set the FM ST./MO. Switch located on the left side of the radio to to FM ST. (stereo) position, If the station being received is weak some hiss may be audible, to reduce the hiss, set the switch to FM MO. (mono) position to return to mono operation.

Note: FM stereo is only available via earphones.

Headphones (or earphones)

Headphones for use with this radio should be stereo and fitted with a 3.5 mm stereo jack plug. Insert the headphones plug into the socket marked (ST) on the left side of the radio. When the headphones are plugged in, the loudspeaker is automatically disconnected.

Lock switch

The lock switch is used to prevent unintentional operation of the radio.

Set the Lock switch on the right side of the radio to the On position. The Lock icon will appear in the display. The POWER and all other button will be disabled. This will prevent accidental operation when the radio is packed in a suitcase or carrying Pouch. To release the Lock switch, move the switch to OFF position, the LOCK icon Will be removed from the display.

Light

Press the light button will turn on the light and illuminate the display for approx. 7 seconds after last operation. Or you may turn it off by another press to the light button.

DX/Local switch

When listening to SW/FM broadcasting, this switch adjusts the receiver's sensitivity. When you listen to a strong station and the signal is slightly distorted, set the switch to the LOCAL position for best reception. For normal or weak stations, set the switch to the DX position for maximum sensitivity.

SW EXT. ANT

To improve SW reception, you can connect an optional external directly to the SW EXT ANT jack on the left side of the receiver. This automatically disconnects the receiver's built-in antenna.

Follow the antenna's supplied instructions to connect it to the receiver.

Troubleshooting/RESET button

If the radio fails to operate correctly, or some digits on the display are missing or incomplete. carry out the following procedure.

1. Switch off the radio and remove the batteries.
2. With the aid of a suitable implement (the end of paper clip or pen), press the RESET button located at the bottom side for at least 1 seconds, this will reset the Microprocessor, clock time and clear all stations stored in the preset memory.

Care and maintenance

Do not allow this radio to be exposed to water, steam or sand. Do not leave the radio where excessive heat could cause damage such as in a parked car where the heat from the sun can build up even though outside temperature may no seem too high.

Specifications

Frequency range

FM		87.50 - 108	MHz
MW		520 - 1710 or 522 - 1710	kHz
SW	120 m	2.3 - 2.495	MHz
	90 m	3.2 - 3.4	MHz
	75 m	3.85 - 4.0	MHz
	60 m	4.75 - 5.06	MHz
	49 m	5.9 - 6.2	MHz
	41 m	7.1 - 7.35	MHz
	31 m	9.4 - 9.99	MHz
	25 m	11.6 - 12.1	MHz
	21 m	13.5 - 13.87	Mhz
	19 m	15.1 - 15.8	MHz
	16 m	17.48 - 17.9	MHz
	15 m	18.9 - 19.02	MHz
	13 m	21.45 - 21.75	MHz
	11 m	25.6 - 26.1	MHz

Specifications content

Power requirement	6V
Batteries	4 X IEC size LR6 (AA) (UM-3)
Circuit features	
Semiconductors	1 LSI 7 IC's, 35 transistors, 7 FET, 33 diodes, 3 LED
Aerial system	AM/LW Built in ferrite aerial SW Telescopic aerial FM Telescopic aerial
Output Power	300 mW 10% T.H.D.
Sockets	
Headphones socket	3.5 mm dia. stereo
DC in	6 volts center pin negative
Accessories	Carrying pouch and earphones (Accessories may be different from each market.)
Dimension (mm)	214 (W)X128 (H) X 38.50 (D)
Weight	840g without batteries