

SANGEAN



CONTENTS

Features	2
Control Locations	3
Display Information	7
Choosing a Power Supply	8
Preliminary Settings	13
Zero Second Set	19
Tuning Mode	23
Scan Tuning	32
Memory Tuning	35
ATS(Auto Tuning System)	43
Clock Radio Operation	47
Miscellaneous Controls	58
Care and Maintenance	62
Specifications	65

FEATURES

- Continuous tuning-permits reception of more stations than ever before without any break between LW, MW or SW bands.
- Large easy to read LCD display indicates station frequency, dual time, memory locations and all the functional status.
- Direct access keypad permits instant tuning of any desired frequency.
- Fifty-four memory presets offer instant access to your favorite stations on LW , MW , FM and SW.
- Supplemental tuning control allows for maximum clarity of the selected frequency.
- Dual time setting allows you to preset your local time or UTC time ,or any two time zones with instant recall.
- Scanning circuit permits you to check various frequencies on a certain band-width and lock on to it at random.
- Cancel button allows you to instantly change incorrect information keyed into the microprocessor.
- SW meter band select buttons offer instant selection of any desired frequency bandwidth on SW.
- Dual Alarm Feature allows presetting two wake up times for clock alarm.
- ATS(Auto Tuning System) which will automatically scan and select presets based on station signal strength on FM,MW and LW band.
- Adjustable sleep timer allows you to fall asleep to music.
- Standby mode turns on the radio automatically at 2 preset times either by radio program or HWS buzzer.
- 1 kHz/step fine tuning on AM (MW/LW/SW)band.

CONTROL LOCATIONS

- 1.Power on/off and sleep button.**
- 2.Fine tuning button.**
- 3.Manual tuning/auto scan button.**
- 4.Enter command button/Display button to display frequency or time.**
- 5.Memory entry and time set button.**
- 6.Frequency select button.**
- 7.Cancel button.**
- 8.Dot,memory scan and zero second set button.**
- 9.Digit button for frequency,time,SW meter band and memory page 1 or 2.**
- 10.Multi functions for FM band knob,FM ATS and exchange dual and real time in time mode.**
- 11.Multi functions for LW band knob,LWATS and Standby by radio.**
- 12.Multi functions for MW band knob,MW ATS and Standby by HWS buzzer.**
- 13.Multi functions for SW band knob, SW meter band and counting down timer.**
- 14.LCD display.**
- 15.Light button to light LCD display 12 seconds for every push.**
- 16.Tuning LED indicator.**

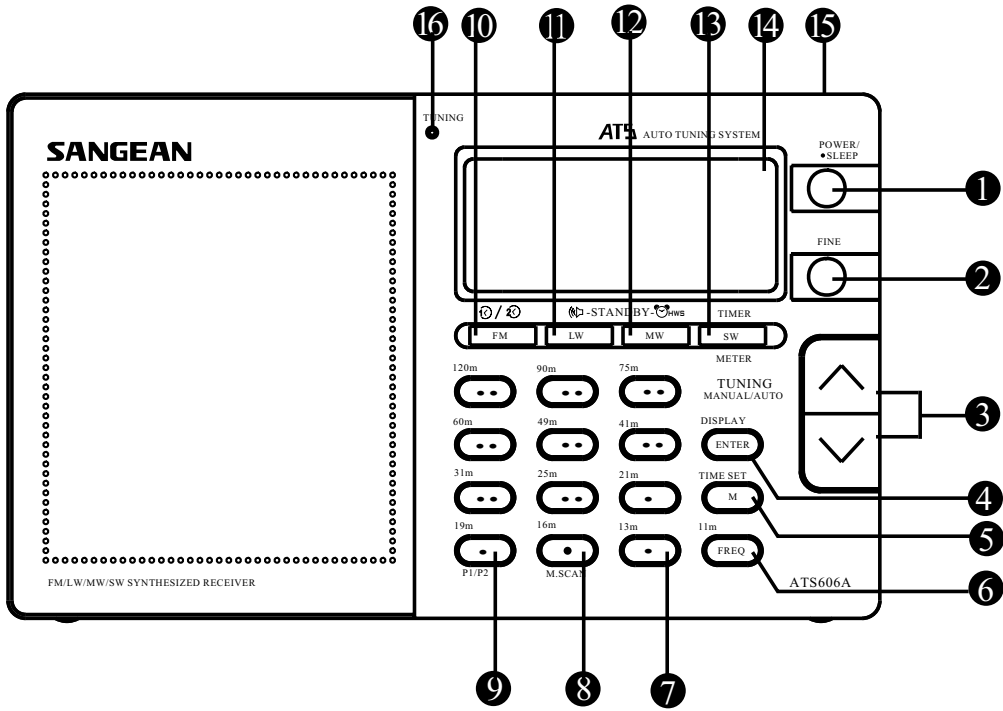
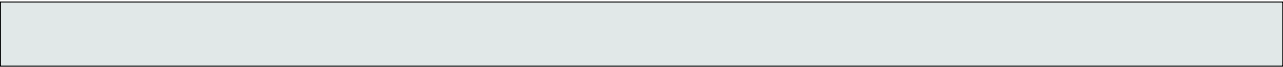

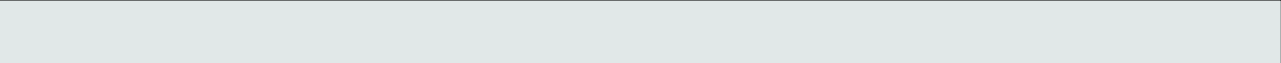

17. Earphones jack.

18. AC adaptor jack.

19. AM external antenna jack.

20. FM stereo. mono/AM sens-DX. local mode selector.

21. Telescopic Antenna.

22. Volume control.

23. Lock switch to avoid misoperation.

24. Folding stand.

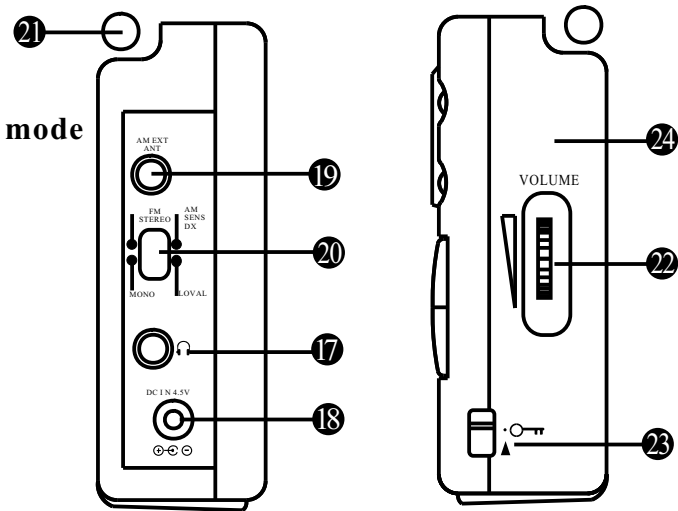



25. Reset button to clear all the presets in the microprocessor except the SW preset stations.

26. 9K/10K MW step switch.

27. Battery compartment.

28. Battery cover.

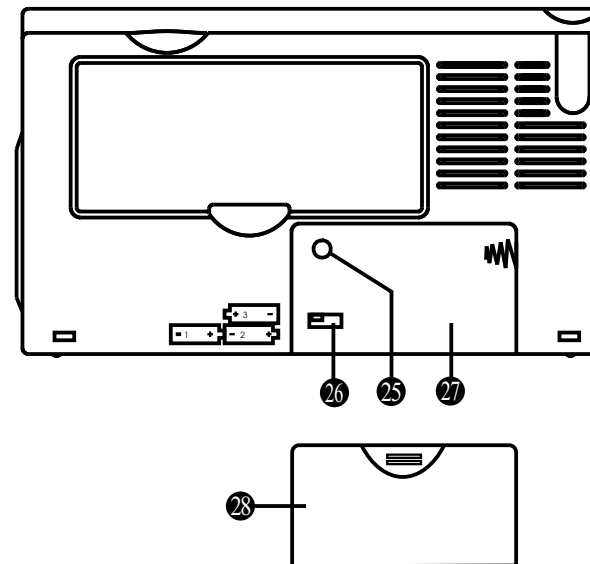

DISPLAY INFORMATION

1. Band indication.
2. Time set status.
3. Time adjustment and zero second set indication.
4. Memory presets.
5. Memory Page 1 and Page 2 for SW/FM bands.
6. Sleep status.
7. Lock on.
8. FM stereo indication.
9. SW meter band.
10. Auto Tuning System status.
11. Low battery.
12. kHz for MW and LW, MHz for FM and SW.
13. Frequency and time display.
14. Time area 1 or 2.
15. Standby by radio.
16. Standby by HWS buzzer.
17. Counting down timer status.
18. Memory preset, battery strength and scanning status during ATS.
19. Fine tuning status.

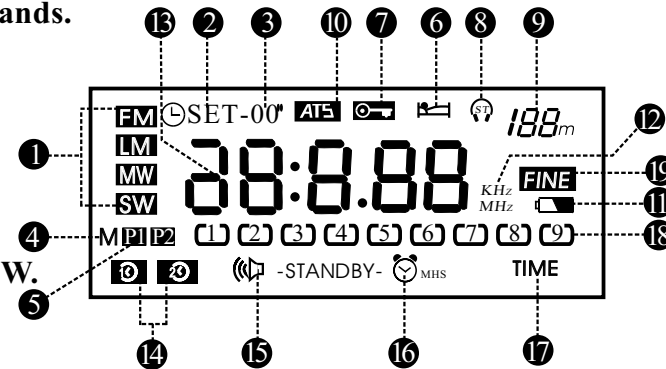

CHOOSING A POWER SUPPLY

You can operate the receiver using

- * 3 Alkaline AA(UM-3) batteries.
- * Household AC adaptor.(optional)

USING BATTERIES

1.Press latch marked "OPEN" on battery compartment covers in the direction of the arrow and lift off cover.

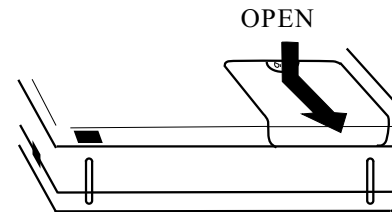

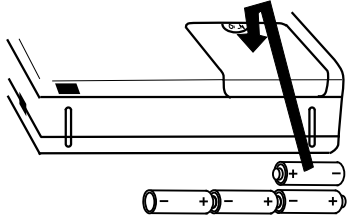
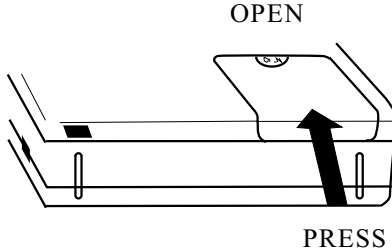

<p>2. Insert 3 "AA" battery in battery compartment as indicated in diagram. Be sure to position them on the back of the radio and on top of lift out ribbons for easy removal.</p>	
<p>3. Replace battery cover and press down until you hear it snap closed.</p>	



BATTERY REPLACEMENT

Whenever the radio is turned off, the battery indicator will show for about 7 seconds to show battery condition. If the indicator falls below 2 the batteries should be replaced. Be sure to replace the battery Within 3 minutes to secure time and all memory functions.

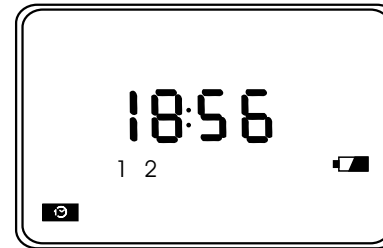

USING HOUSE CURRENT AC ADAPTOR

The receiver may be powered by using AC adaptor. Insert the plug into the jack on the side of the radio marked **DC IN 4.5V**. Plug the other end of the adaptor into a standard household outlet. Whenever **AC** adaptor is used, the batteries are automatically disconnected.

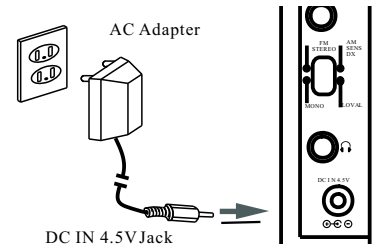

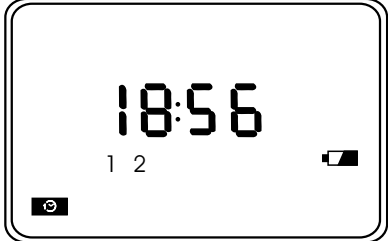
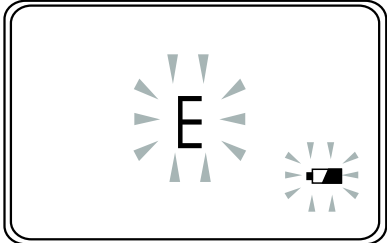

TIME TO REPLACE BATTERIES

<p>1. Turn off the power and battery indicator falls below 2 .</p>	
<p>2. IF "E" flashes on LCD and low battery indicator is displayed when radio is turned on batteries should be replaced.</p>	



<p>3. Whenever the low battery indicator appears on LCD display, batteries should be replaced.</p>	
--	---

PRELIMINARY SETTINGS

SETTING THE CLOCK

The time is displayed in the 24 hours mode since most shortwave broadcasting stations operate according to Greenwich Mean Time .This is the standard that is used through the world.

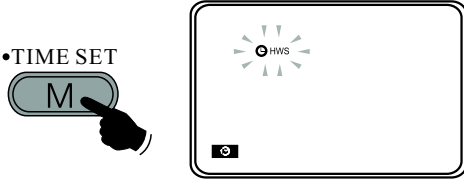
1. The clock will start when 3 "AA" batteries are installed. The display shows 0:00	 A rectangular digital display with a black border. The screen shows the time '0:00' in a large, black, digital font. In the bottom-left corner of the display, there is a small square icon containing a circle with a dot inside.
2. Press "TIME SET" key for more than 2 seconds, display will show " ⌚ SET" and flash.	 A hand is shown pressing a button labeled 'M'. Above the button, the text '•TIME SET' is written. To the right of the hand and button is a rectangular digital display with a black border. The screen shows a clock icon (a circle with radiating lines) and the text 'HWS' next to it. In the bottom-left corner of the display, there is a small square icon containing a circle with a dot inside.





<p>3.While "⌚SET" is flashing ,set the correct time by pressing the numbered buttons .As you press the corresponding button the number shows up on the LCD display</p>	
<p>4.If you press the wrong number, press the "C" (cancel) button which deletes one number at a time .</p> <p>Note :Time can be adjusted only when "⌚SET" is in flashing mode.</p>	

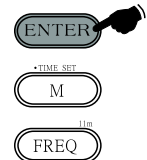



<p>5. Now press button "ENTER", display will show hours and minutes.</p>	
--	---

SETTING DUAL TIME

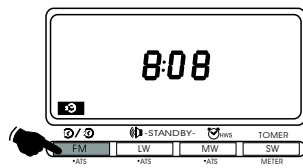
A second time zone can be programmed into this unit such as your home time if you are travelling, or Greenwich Mean Time for instant access to shortwave broadcasting or local time wherever you are .

<p>1. Press  /  button and display will show and flash .</p>	
--	--

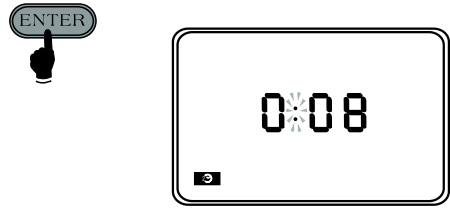

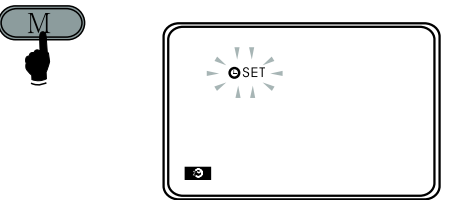
<p>2. Press "ENTER" button within 3 seconds, display  will stop flashing.</p>	 <p>The diagram shows a hand pressing a button labeled "ENTER". To the right is a digital display showing "0:08" with a flashing clock icon in the center. A small square icon with a right-pointing arrow is in the bottom left corner of the display.</p>
<p>3. Press "TIME SET" button for more than 2 seconds, display  SET will flash.</p>	 <p>The diagram shows a hand pressing a button labeled "M". To the right is a digital display showing "SET" with a flashing clock icon in the center. A small square icon with a right-pointing arrow is in the bottom left corner of the display.</p>



4. While "⌚ SET" is flashing, set the correct time by pressing the corresponding buttons. The numbers will show up on the LCD display.

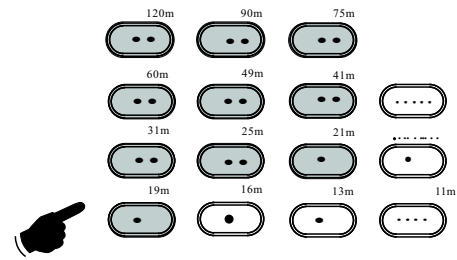



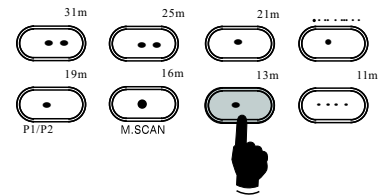

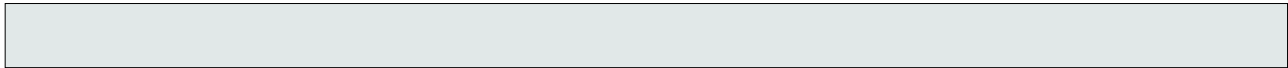
5. If you press the wrong number, press the "C" button which deletes one number at a time.



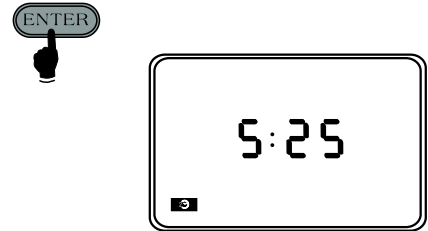

6. Now press button "ENTER" ,display shows hours and minutes.



7. Push / button and "ENTER" again to back to  time.

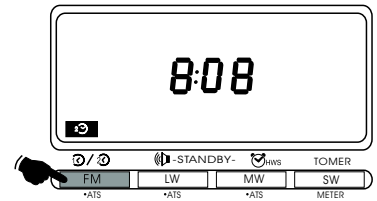

ZERO SECOND SET

During time set period, display shows "⌚SET", press **0'set** button, display will show "SET-00" and flash. Now press "**ENTER**" button, the clock will start from its zero second.

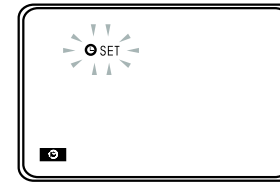
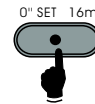



BAND SELECTION

There are four band selector buttons located just beneath the LCD display.

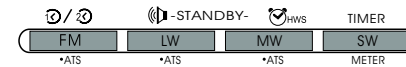

BAND	FREQUENCY		PROGRAM TYPE
FM	87.5-108	MHz	Standard FM
LW	153-513	kHz	Longwave
MW	520-1710	kHz	Standard AM
SW	1.711-29.999	MHz	SW/13 sub-bands



1. Turn radio on by pressing **"POWER/SLEEP"** button. Display will show last band and frequency selected.

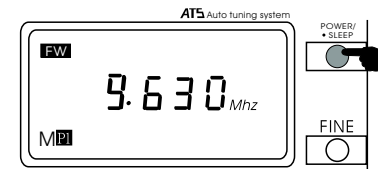

2. By pressing any of the four band selector buttons, last frequency used within that band will appear.

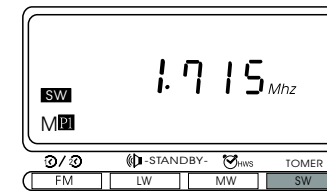



Note:

*If you select SW, pressing "SW/METER" button again will display a flashing "m" indicating any meter band may now be selected. For example press button **6/41m**, display will show lowest frequency of 41 meter.i.e 7.100 Mhz.*

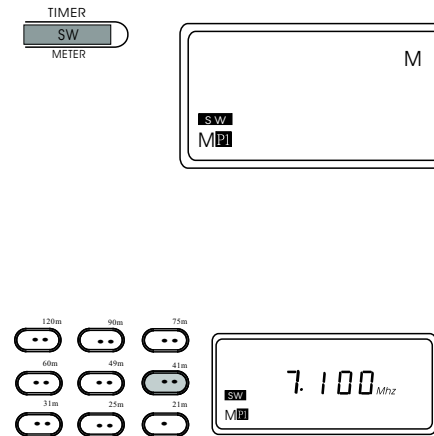

TUNING MODE

ADJUSTING THE ANTENNA

Locate the band you want to listen to in the following chart and adjust the antenna as indicated.

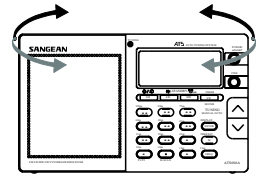
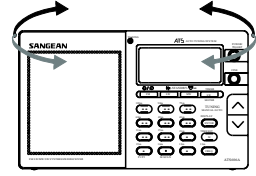
<i>BAND</i>	<i>FREQUENCY RANGE</i>	<i>ANTENNA TYPES</i>	<i>ILLUSTRATION</i>
MW	520-1710 kHz	INTERNAL Rotate radio for best reception	
LW	153-513 kHz	INTERNAL Rotate radio for best reception	

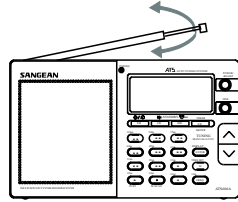
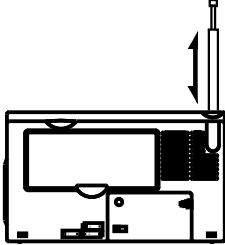

FM	87.50-108 MHz	TELESCOPIC Extend antenna all the way and rotate it for best reception.	
SW	1.711-29.999 MHz	TELESCOPIC Extend antenna all the way for best reception but do not rotate.	



You may select five different tuning methods to choose the frequency and station broadcasting you prefer.

.Direct Tuning . Manual Tuning . Scan Tuning

.Memory Recall Tuning .ATS Tuning on FM,LW and MW bands.

DIRECT TUNING

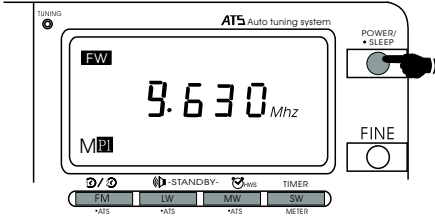
Example: To tune 100.70 MHz on the FM band, follow this procedure

<p>1. Press the "POWER/SLEEP" button to turn on the radio.</p>	 <p>The diagram shows a car radio control panel. At the top, it says "ATS Auto tuning system". The central display shows "FM" in a box, "9.630 MHz", and "MP3" in a box. Below the display are several buttons: a power/sleep button (a circle with a dot), a "FINE" button (a circle), and a row of four buttons labeled "FM", "LW", "MW", and "SW". Below these buttons are smaller labels: "ATS" under FM, "ATS" under LW, "ATS" under MW, and "METER" under SW. To the right of the display is a "POWER/SLEEP" button with a dot and a "FINE" button.</p>
<p>2. Press the button marked FREQ (Frequency).</p>	 <p>A close-up diagram of a button with three dots on it. A hand is shown pressing the button.</p>

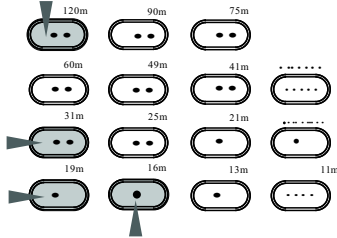
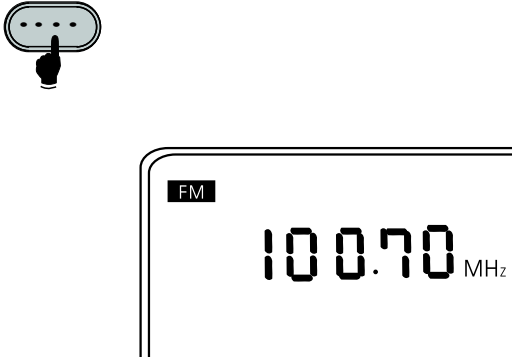

<p>3. Press the corresponding buttons marked [1], [0], [0], [.] , [7], [0], That exact frequency will now show up in the display.</p>	
<p>4. Press the button marked "ENTER" , the frequency and band will now show up in the display.</p> <p>Note: Be sure to press the decimal point[.] in 100.70 MHz otherwise the display will show SW [10.070 Mhz].</p>	

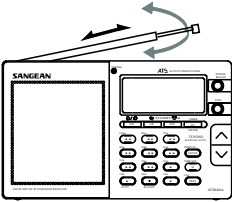
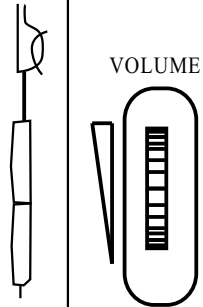

<p>5. Extend the antenna all the way and rotate for best FM reception.</p>	
<p>6. Adjust the Volume control for comfortable listening.</p>	



7. When selecting a FM stereo station, and using stereo earphones, make sure the FM mode switch is in the STEREO position.

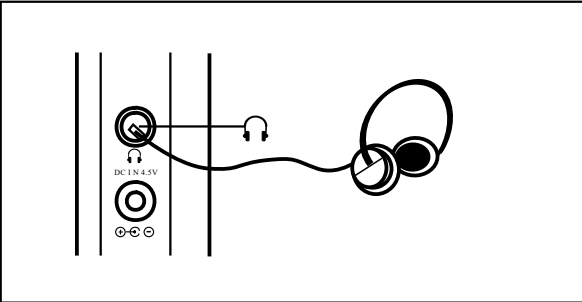

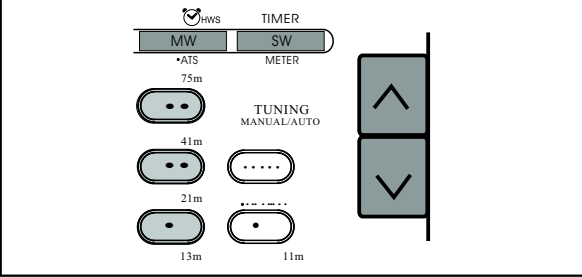

MANUAL TUNING

To select a station when you do not know the frequency, use the Manual Tuning [Δ] [V] button.



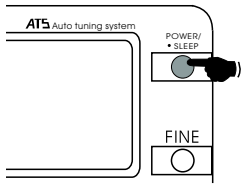

<p>1. Press the "POWER/SLEEP" button to turn on radio.</p>	
<p>2. Select a band.</p>	



3. Press repeatedly the [Δ] or [V] buttons to reach a desired frequency. Press and hold the [Δ] or [V] button for more than half a second to change frequency rapidly.

Note:

When you repeatedly press the [Δ] or [V] button, the frequency change in increments of
FM: 100 kHz
LW: 9 kHz
MW: 9 kHz or 10 kHz
SW: 5 kHz

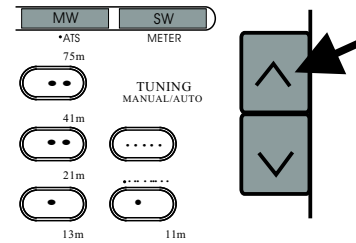



MEMORYSCAN

If you would like to scan the preset stations all in your memory. Press M. Scan button the radio will start memory scan from the last station you were and stops for 4 seconds for every preset station then moving forward to next preset station until you press any functional buttons (except POWER and LIGHT) to stop the memory scan.

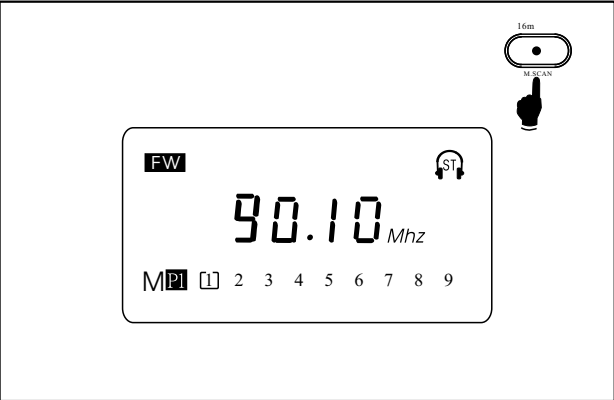

SCAN TUNING

Use scan tuning to rapidly locate a station or to monitor several station within a specific band.

1. Turn on radio by pressing "**POWER/SLEEP**" button.

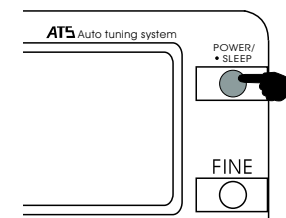

2. Select a band.



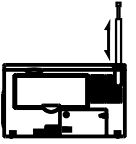
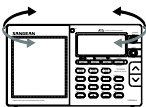
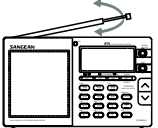
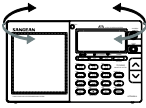
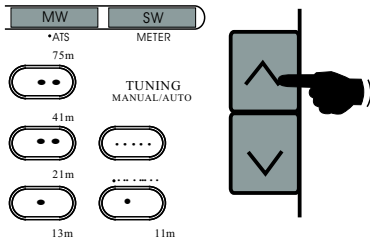

<p>3. Adjust antenna or radio position depending on the selected band.</p>	<p>SW</p> 	<p>LW</p> 
<p>4. Press and hold the [^] or [v] buttons for more than half a second, the radio will scan all the frequencies in the Selected band and will stop automatically each time it lands on an active station.</p>	<p>FM</p> 	<p>MW</p> 
 <p>MW SW *ATS METER 75m 41m 21m 13m 11m TUNING MANUAL/AUTO</p>		



5. Press and hold the [\wedge] or [\vee] button again to resume scanning. When you reach the upper or lower limits of the band, the scanning starts over again as long as the button is depressed.

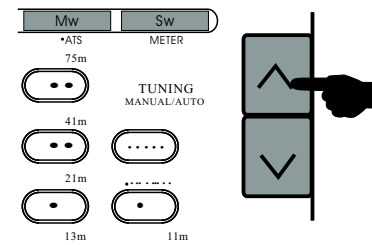

6. Adjust Volume control for comfortable listening.

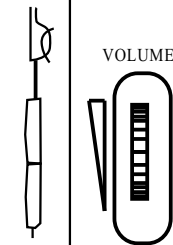

MEMORY TUNING

You may store up to 18 presets on FM/SW, and 9 presets on each of the , LW and MW bands for instant selection of your favorite stations.

STORING A FREQUENCY

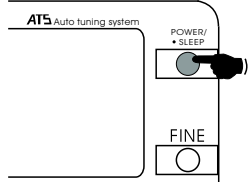
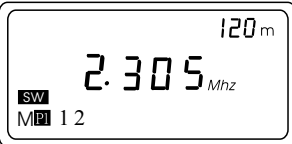
1. Press " POWER/SLEEP " button to turn on radio.	
2. Tune to any frequency using any of the previously mentioned tuning methods.	



3. Press the button marked "M" (memory), display "M" and suggested preset number will flash for 12 seconds. If preset 1 and 2 have been stored, it will suggest preset 3 at this stage, on display preset 3 will flash.



4. Press "ENTER" button and your station will be stored in that memory position.

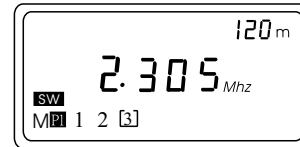



5. Preset positions may be exchanged easily and at any time. Select preset that is to be changed, push memory button, ("M" and existing position will flash) while flashing select new preset position. Presets will be exchanged automatically.

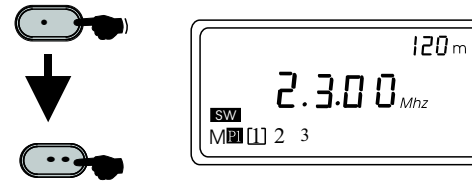

6. FM/SW bands have 18 presets. Presets 1-9 are set in normal manner. When **P1** presets 1-9 are full selecting another station to be preset will display the "**P2**" display and an additional 1-9 presets can be set for a total of 18 presets.

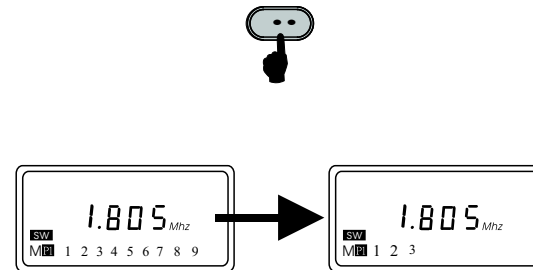

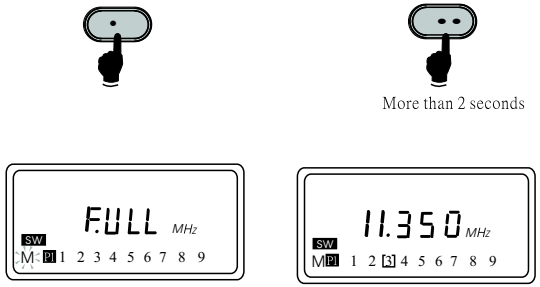
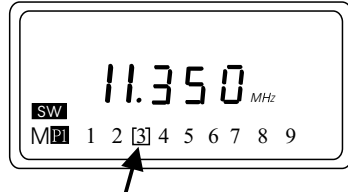

<p>Note</p>	 <p>More than 2 seconds</p>
<p>1.If all presets have been used pushing "M" button will display "FULL" on LCD. If you still desire to store new station push any button 1-9 where new station is to be positioned and hold for more than 2 seconds. New station will be put into memory in position selected and original station in this position will be canceled.</p> <p>2.All preset stations are indicated by [] on the display. If a station has already been preselected it will always show preset position on display.</p>	 <p>The mark "[]" indicate he frequency has been stored</p>



RECALLING APRESET

1. Press **"POWER/SLEEP"** button to turn on radio.

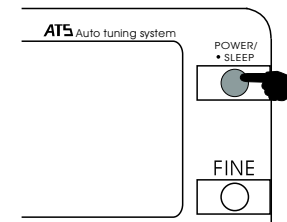

2. Select a band in which a station is stored that you want to recall.

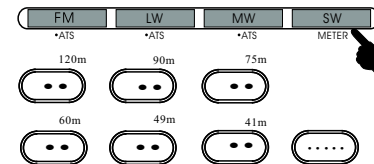



1. Press any of the **NUMBERED** buttons for a desired station and the radio will instantly tune to it. Display will show frequency and Memory position. If you want to change to another preset station just press any other numbered button for access. For SW/FM preset 01-09, push "**P1/P2**" button first then any of 1-9.

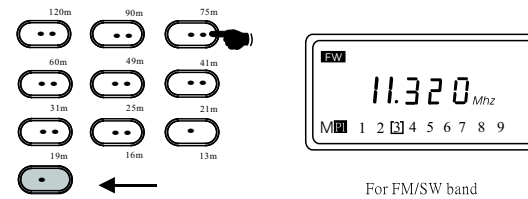

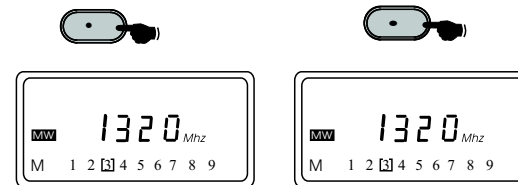

CANCELLING PRESET

1. Recall a preset station, push "**M**" button. On display "**M**" and preset digit will flash, push "**C**" button to cancel the preset.



EXCHANGE THE PRESET

If you want to exchange preset 2 to preset 7 for editing the memory.

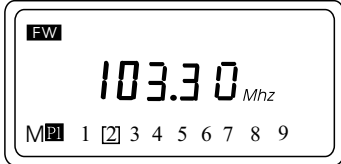
1.Recall preset 2.	 
2.Push "M" and display "M" and preset 2 will flash.	 



3. Push 7 then preset 2 and preset 7 have been exchanged.



ATS (AUTO TUNING SYSTEM)

This radio provides an excellent and easy to use feature called ATS (Auto Tuning System) which is available on FM, LW and MW bands.

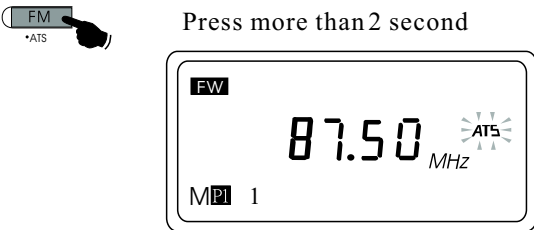
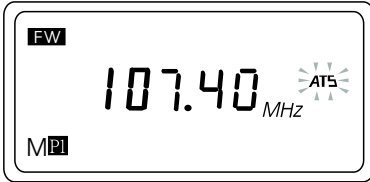
<p>1. Push any of FM/LW/MW band buttons for more than 2 seconds. The radio will start with a beep tone and display ATS will flash indicating the radio is in ATS mode.</p>	 <p>Press more than 2 second</p>
<p>2. The radio will then scan from the lowest frequency of the Selected band and automatically preset the stations based on station signal strength in order from Memory 1-9.</p>	

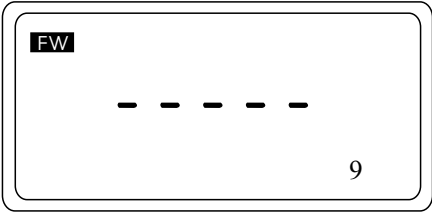

<p>3. After the whole scanning is completed, a beep tone will be heard. Display will show M[1] and the frequency which is the strongest signal in your area will be heard.</p>	
<p>4. If no stations are found, display will show '----' for 2 seconds and return to last tuning frequency.</p>	

Note:

1. Maximum presets on MW and LW are 9 and 18 on FM, and if the auto preset stations are more than 9 for MW/LW bands, 18 for FM band, the microprocessor will pick up only 9 stations for MW/LW bands and 18 stations for FM band into 2 memory pages (P1/P2) based on signal strength.
2. If the auto presets are less than 9, display will show actual auto preset stations found. For example, if only 5 stations are preset, display will show [1] 2 3 4 5, when the scanning is completed.
3. SW band has no ATS function.
4. When ATS starts to function, it will clear all the original presets.
5. When ATS starts to function, it can be terminated by pushing "POWER/SLEEP" button. During ATS function, all the other functional buttons will not work except **light**, "POWER/SLEEP" and **lock** button.



FINE TUNING

To have best reception, while is necessary, press fine tuning button FINE, LCD will appear FINE indicating now is under Fine tuning status. The tuning step now will become 1 kHz/step on AM(MW/LW/SW) band and 50 kHz/step on FM band while pressing tuning [Δ]or[V] button.

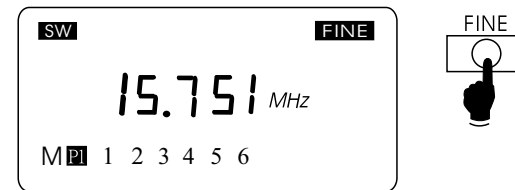

CLOCK RADIO OPERATION

With this radio you can fall asleep to your favorite station by pressing the **"POWER/SLEEP"** for more than 2 seconds or wake you up to the morning news or an alarm buzzer. This radio provides two alarm times that you can set for two different wake up times at the same time.

SETTING THE ALARM (STANDBY)

The alarm can be set

1. While radio power is off.

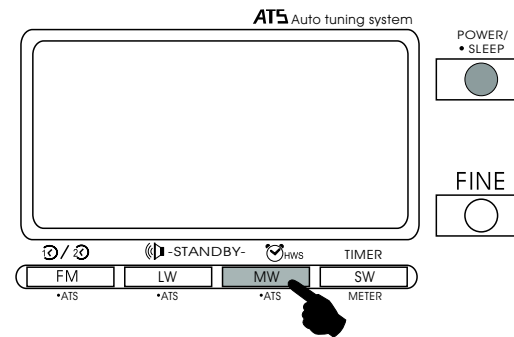

2.If power is on, push **"DISPLAY"** button to time mode.

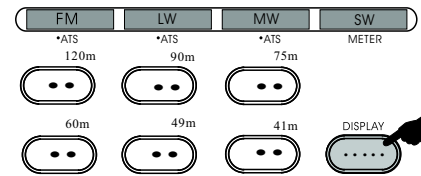

SETTING ALARM (STANDBY) BY RADIO

1.When the display is in the time mode, press **"(🔊) -SEANDBY"** button, display **"(🔊) -STANDBY"** will flash and show last alarm time (0:00 for the first time).

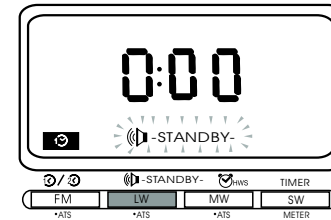



1. Press the numbered buttons to activate alarm-on time. Using 24 hour time, an example will be, if you set the alarm on time at 1:30PM, press the button [1][3][3][0] and "ENTER" button. Display will show 13:30 and "STANDBY" will stop flashing indicating alarmed by radio has been set at 1:30 PM.

If the wrong number was keyed-in, to delete by pressing "C" button. each number for every push on the "C" button.

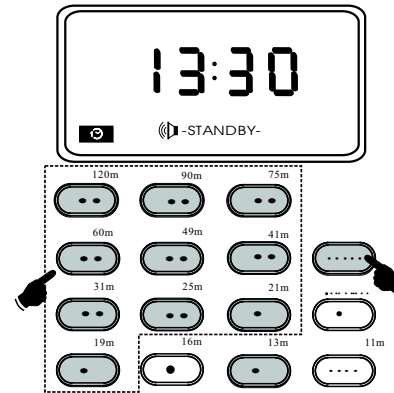

If the time you key in does not exist like 25:30, display will show "E" for about 2 seconds and back to original time.





3. When the alarm time is set, the clock will return to the current time automatically. Meanwhile the colon will start to flash.



4. To verify, press "STANDBY" button then "ENTER" button again.

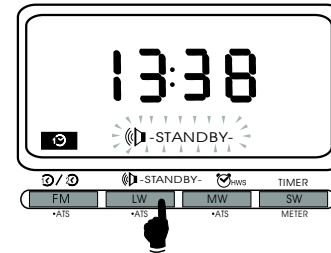



5. To cancel the alarm time, press "**STANDBY**" button and display "**STANDBY**" will flash, press "**C**" button to cancel.

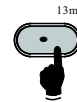

Note

1. When alarm is on press "**POWER/SLEEP**" button to turn off the alarm.
2. The radio alarm will last for one hour if not turned off by pushing **POWER/SLEEP** button.
3. Tune the radio before setting radio alarm. When alarm is on, the radio will play according to last frequency or station selected.

SETTING ALARM BY HWS BUZZER

HWS-Humane Waking system.

A repeating beep tone sounds when using the set buzzer. The alarm buzzer volume increases every 15 seconds for 1 minute then silences for 1 minute before beginning the cycle. Again HWS will continue this pattern for 30 minutes.

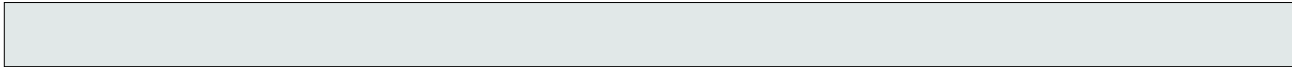

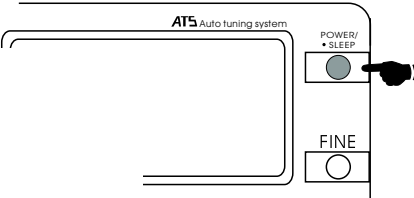
<p>Setting Alarm by HWS buzzer has same procedures as setting alarm by radio except pushing "STANDBY-🕒 HWS' button instead.</p> <p>Turn off the HWS buzzer by pushing "POWER/SLEEP" button.</p>	
---	---

COUNTING DOWN TIMER

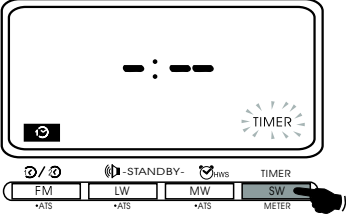
<p>1. Press "TIMER" key, "TIMER" display will flash</p>	
---	--

2. Use 0-9 button to key in required time (Max 23 hours and 59 minutes).

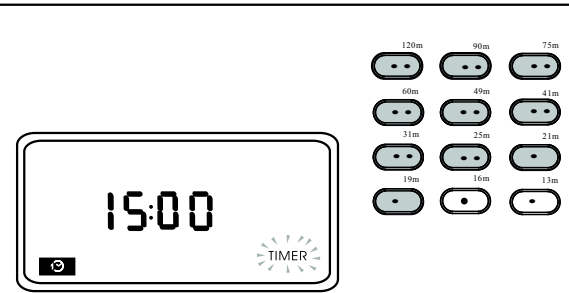

3. Press "ENTER" button, "TIMER" display will stop flashing indicating Count Down timer has been set. Display will be back to real time within 7 seconds after time is set.



4. Push **"TIMER"** button again to see remaining time.
- a. Push **"TIMER"** button again to continue timer function.
 - b. Push **"ENTER"** button to re-start timer function.

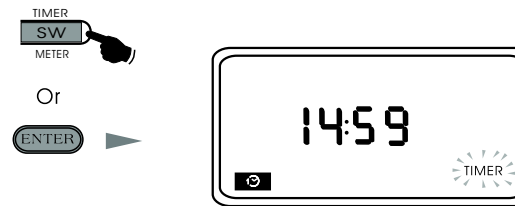

5. When timer is on, buzzer will last for one minute, to turn off the buzzer, push **"POWER/SLEEP"** button.

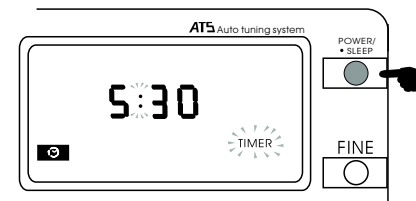

6. To cancel timer setting:

- a: Press **"TIMER"** button. Display shows remaining time.
- b: Press **"C"** button **"TIMER"** on the display will disappear, and display will show real time immediately.

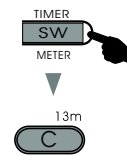

Note

- 1. When alarm is on, press **"POWER/SLEEP"** button to turn off the alarm.
- 2. The alarm will last for one minute if not turned off by pushing **"POWER/SLEEP"** button.
- 3. For initial operation on timer, display will show **--:--** Meanwhile press **"ENTER"** button, display shows **"E"** to indicate error operation.

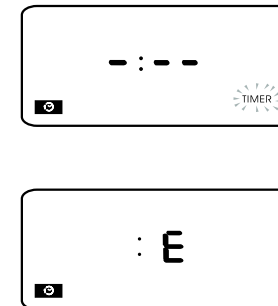

SETTING THE SLEEP TIMER

You can set the sleep timer with the radio on or off.

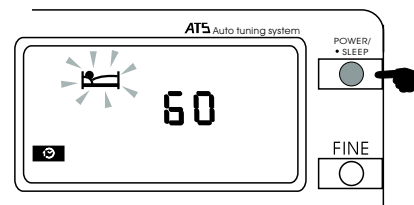

1. Push **POWER/SLEEP** button for more than 2 seconds, LCD  will show indicating the radio is in sleep (auto shut off) function. A buzzer will be heard this time, if the radio is on.

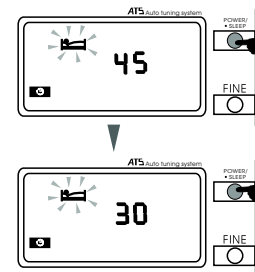

2. Continue pushing "**POWER/SLEEP**" button. Sleep time can be adjusted by 60-45-30-15-60.



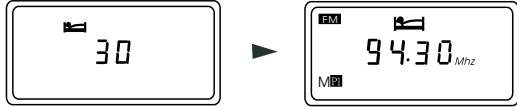

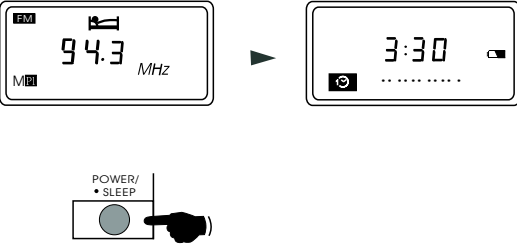
<p>3. Release "POWER/SLEEP" button whenever the sleep time shown on the display is acceptable to you.</p>	 <p>The diagram shows two rectangular display screens. The left screen displays a battery icon, a signal strength icon, and the number '30'. An arrow points to the right screen, which displays 'FM' and 'MHz' in the top corners, a battery icon, a signal strength icon, and the frequency '94.30 MHz'.</p>
<p>4. To cancel sleep function, simply push "POWER/SLEEP" key. Display "  " will disappear and return to the real time.</p>	 <p>The diagram shows two rectangular display screens. The left screen displays 'FM' and 'MHz' in the top corners, a battery icon, a signal strength icon, and the frequency '94.3 MHz'. An arrow points to the right screen, which displays '3:30' and a battery icon. Below the screens is a button labeled 'POWER/SLEEP' with a small dot above the text. A hand icon is shown pressing the button.</p>

MISCELLANEOUS CONTROLS

In addition to the standard tuning methods described previously, use following controls for special operations.

MONO LOCAL STEREO DX SWITCH

1. When listening to FM stereo broadcasting and using earphones, set the switch to **STEREO** position to enjoy stereo programs.

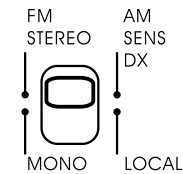

2. When listening to AM (MW/LW/SW) broadcasting, this switch adjusts the receiver's sensitivity. When you listen to a strong station and the signal is slightly distorted, set the switch to the **LOCAL** position for best reception. For normal or weak stations, set the switch to the **DX** position for maximum sensitivity.

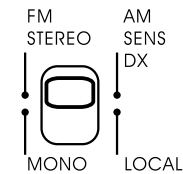

HEADPHONE USE

While not a control, you may consider using Headphones to obtain the best audio clarity when listening to SW. Since many SW stations broadcast only marginal signals, using Headphones will enable you to distinguish between the signal and the noise usually encountered at night. Be sure that, the Headphones terminate in a 1/8 inch plug, which is inserted into the Headphones jack located on the side of the radio, marked with the symbol "🎧". When the Headphones are plugged in, the speaker is muted.

Because the radio is capable of receiving FM stereo, the Headphones should be stereo so that your listening will be enhanced, When listening to stereo FM, be sure that the FM STEREO/MONO switch is set to the stereo position. This switch is located on the side of the radio.

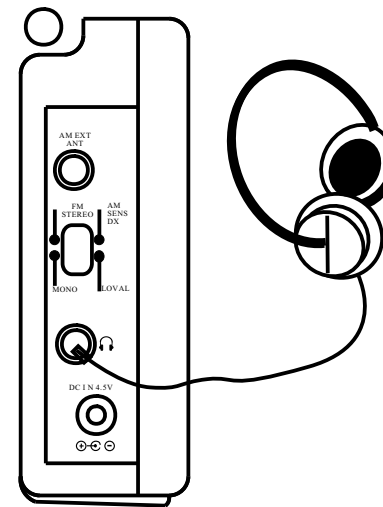

LOCK SWITCH

Using the **LOCK** switch prevents unauthorized operation of the radio and will also prevent the station you are listening to from being changed. When the **LOCK** switch is moved to its up "🔒" position, the **POWER/SLEEP** button and all tuning control buttons are completely disabled. If the radio is on, you will not be able to turn it off. This will also prevent it from being turned on by accident when packed in a suitcase or carrying pouch. If the **LOCK** switch is on, display will show "🔒". To release the **LOCK** switch, simply move the switch down.

EXTERNAL ANTENNA USE

To obtain optimum performance from this radio, especially when listening to SW, an external antenna should be used, if at all possible. The antenna is connected to the External Antenna Adaptor and then plugged into the **AM EXT ANT** Jack located on the side of the radio.

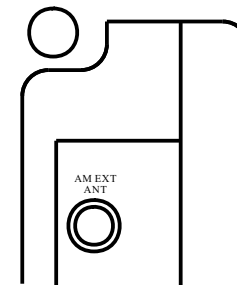
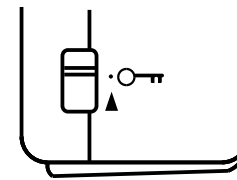

MW STEPSELECTOR SWITCH

Located in the battery compartment of the radio, MW step 9K/10k switch provides means to select the incremental frequency steps for MW band, depending upon your geographic location. In the USA or CANADA, 10K steps are used so the switch should be set to 10K position. In the other parts of the world where they use 9K steps, move the switch to the 9K Position.

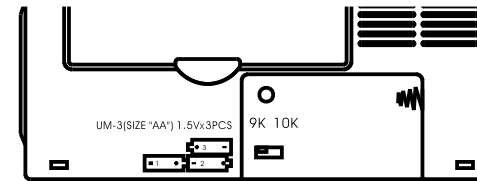

PORTABLE SHORTWAVE ANTENNA (OPTIONAL)

Depending on the selling areas, some of these radios may include a **PORTABLE SHORTWAVE ANTENNA** as a standard accessory to this radio. Move out the connector and connect to the **AM EXTERNAL ANTENNA JACK** of the radio. This **PORTABLE SHORTWAVE ANTENNA** provides a 7 Meters wire antenna, serving as extension to the Telescopic Antenna, so that you won't have to listen to SW broadcasting near the window.





CARE AND MAINTENANCE



This receiver is an example of superior design and craftsmanship. The following suggestions will help you care for the receiver so that you can enjoy it for years.

<p>Keep the product dry. If it does get wet, wipe it dry immediately. Liquids might contain minerals that can corrode the electronic circuits.</p>	
<p>Use and store the product only in normal temperature environments. High temperatures can shorten the life of electronic devices, damage batteries, and distort or melt plastic parts.</p>	



<p>Handle the product gently and carefully. Dropping it can damage circuit boards and cases and can cause the product to work improperly.</p>	 A circular icon with a diagonal slash through it, depicting a hand dropping a device. This is a prohibition sign for dropping the product.
<p>Keep the product away from dust and dirt, which can cause premature wear of parts.</p>	 A circular icon with a diagonal slash through it, depicting a hand blowing dust or dirt onto a device. This is a prohibition sign for exposing the product to dust and dirt.



<p>Wipe the product with a dampened cloth occasionally to keep it looking new. Do not use harsh chemicals, cleaning solvents or strong detergents to clean the product.</p>	
<p>Use only fresh batteries of the recommended size and type. Always remove old or weak batteries. They can leak chemicals that destroy electronic circuits.</p>	
<p>Modifying or tampering with the product's internal components can cause a malfunction and might invalidate the product's warranty.</p>	

SPECIFICATIONS

Frequency range:

FM	87.50-108	MHz
LW	153-513	kHz
MW	520-1710	kHz/522-1710 kHz
SW	1.711-29.999	MHz

Includes short wave 13 meter bands

120m	2.300- 2.495	MHz
90m	3.200- 3.400	MHz
75m	3.900- 4.000	MHz
60m	4.750- 5.060	MHz
49m	5.900- 6.200	MHz
41m	7.100- 7.350	MHz
31m	9.400- 9.900	MHz
25m	11.600-12.100	MHz
21m	13.570-13.870	MHz
19m	15.100-15.800	MHz
16m	17.480-17.900	MHz
13m	21.450-21.750	MHz
11m	25.600-26.100	MHz



Semi conductors: 1 LSI, 10 IC, 8 FET, 24 Transistors, 25 Diode, 2 LED.

Circuit: FM : Heterodyne
AM(LW,MW,SW) : Double-conversion Heterodyne

Antennas: LW/MW : Built-in Ferrite Bar Antenna
SW : Telescopic Antenna or External Antenna(not included)
FM : Telescopic Antenna

Speaker output power: Nominal 180 mW at 10% T.H.D.

Jack: 1.DC Jack for external power 4.5V
2.Headphones Jack-3.5 for mini stereo headphones
3.AM EXTANT Jack

Power source: 1.3 AA(UM-3) batteries.
2.AC adaptor 4.5V/250 mA center negative

Dimension: 148(L)×89(H)×30(T) m/m

Weight: 300g (without battery)

Accessories: Carrying pouch, stereo earphones, AC adaptor and **PORTABLE SHORTWAVE ANTENNA**. However accessories may be different depending on area.